

NSX-2100V

STANDARD SPECIFICATION

Model NSX-2100V

Trace Nitrogen, Sulfur and Halogen Analyzer system utilizing oxidative sample combustion.

Trace Elemental Analyzer NSX-2100V	
Samples	Non-aqueous liquid, Gaseous, LPG, Aqueous (Nitrogen)
Analytical method	Oxidative Pyrolysis and detection
Furnace	Max. 1,100°C, two part independent controlled. Vertical Electric Furnace VF-210. Open/Close type.
Detector	Ultraviolet Fluorescence (UVFL) for Sulfur - Model SD-210. temperature controlled cell Chemiluminescence (CLD) for Nitrogen - Model ND-210. temperature controlled cell Microcoulometry for Chlorine and Sulfur - Model MCD-210.
Measuring range	UVFL-Sulfur 0.02 - 10,000µg/ml CLD-Nitrogen non-aqueous: 0.03-10,000 µg/ml CLD-Nitrogen Aqueous: 0.01 - 5,000µg/ml Coulometry Chlorine 0.01 - 500µg (0.05 - 10,000µg/ml) Coulometry Sulfur 0.02 - 50µg (0.1 - 1,000µg/ml)
Sample size	non-aqueous liquid max. 200µl (aqueous: max. 100µl) gaseous SD-210: max 25ml/GI-220, 10ml/GI-210 gaseous ND-210: max 25ml/GI-220, 10ml/GI-210 gaseous MCD-210: max 100ml/GI-220, 10ml/GI-210 gas/LPG loop 10ml/30µl loop (GI-240, GI-300)
Measuring time	UVFL/CLD ca. 3 min. (simultaneous Nitrogen/Sulfur available) Coulometry less than 10min
Gas	Argon and Oxygen (special version possible for alternative inert gas)
Others	Vacuum pump for ND-210
Electric	100-240VAC 50/60Hz

Module specification	Power consumption	Dimension WDH mm	Mass
Furnace VF-210	1000 VA	500 x 430 x 500	35Kg
Detector SD-210	150 VA	220 x 375 x 500	21Kg
Detector ND-210	300 VA	220 x 375 x 500	22Kg
Detector MCD-210	150 VA	220 x 375 x 500	14Kg

PC	
OS	Microsoft Windows® 10 professional 64bit
Processor	32bit processor, more than 1GHz
Memory	more than 1GB
HD	more than 200GB
Drive	CD-ROM or DVD drive
Display	1024 x 768 or higher
Printer	windows compatible.
Port	1 serial port (RS-232C, D-sub9)

● Configuration and dimension examples (unit: mm)

Two detector system with liquid sampler

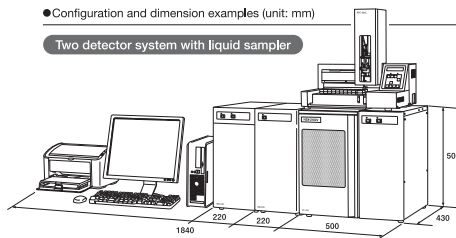

Single detector system with liquid sampler

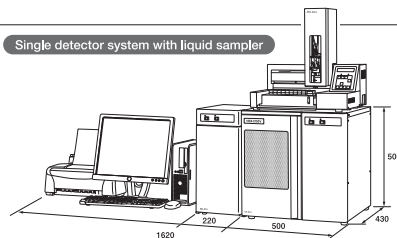

Note: Follow instructions in manuals to correctly install, connect and operate the instruments. Contents of catalogues are subject to change without prior notice when improvements are made in performance. The actual color of the goods may appear different from color printed. All screen images are simulated.
*Company and product names contained herein are the trademarks or registered trademarks of the company concerned.

Nittoseiko Analytech Co., Ltd.

NSX-2100V

Trace Elemental Analyzer
Vertical System



Protection from catalyst poisoning will enhance efficiency of plant operation. NSX-2100V trace analyzer will ensure modern catalyst control.

HIGH END PERFORMANCE, ROBUSTNESS, RELIABILITY, STABILITY.

Real ppb level analysis, Improved trace analysis by temperature controlled cell system.

■ MICRO AUTOMATIC DILUTION (MAD) (OPTION FOR ASC-250L)

Unique, innovative function of ASC-250L liquid sampler. Sample is diluted in the syringe and followed injection directly into combustion furnace to measure automatically. MAD also enables to dilute high concentration sample.

■ ULTRA TRACE SULFUR.

Trap & Release Unit TRU-210 can enhance performance of UVFL sulfur analysis. TRU-210 unit enables measuring limit down to 5 ppb with essential separation of nitrogen.

■ HIGH PRODUCTIVITY, LOW RUNNING COST.

40% faster, 40% less gas consumption than before by newly designed detector. Easy to use by just 2 range sensitivity.

■ EASY DAILY MAINTENANCE.

Open/ close furnace for easy visual check of tube condition.

■ UNIQUE OPTION.

Liquid cooling option enables accurate results for very high volatile samples.

■ MODULARITY, FLEXIBILITY.

Customizable system for today's requirement and for future possibility.

● Excellent stability

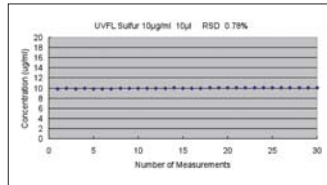

● Ultra trace sulfur option

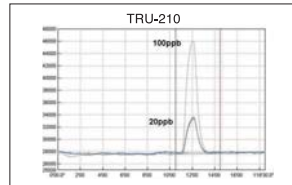

● Faster analysis

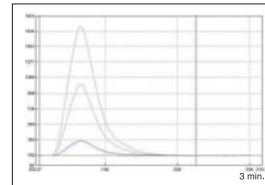

● High sensitivity

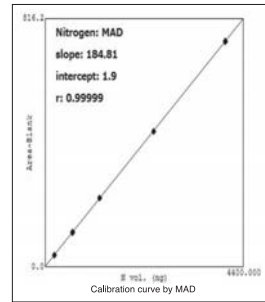

Sample injectors



Detectors



Furnace



Software

Intuitive advanced software will increase usability of protection, operation, and integration.

■ PROTECTION

Three level login function can protect method and data from unintended change.



■ OPERATION

[Stand by] heating, [Auto shut down] function increase operability and save energy.



■ REAL TIME MONITOR OF PEAK PROFILE

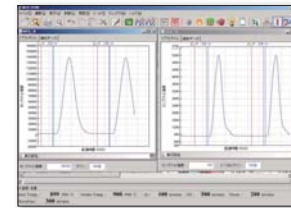

■ CUSTOMIZABLE DISPLAY LAYOUT AS REQUIRED, SIMPLER or DETAIL.

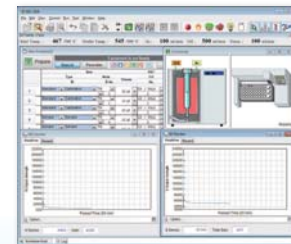

■ LINK to LIMS

Software Add-in will make data handling easier. Output in various file formats (CSV, txt) and via serial port signal (RS-232C) possible.

■ RECALCULATION. SAVING TIME, SAMPLE and WASTE

Stored peak can be recalculated, reduce necessity of re-analysis.

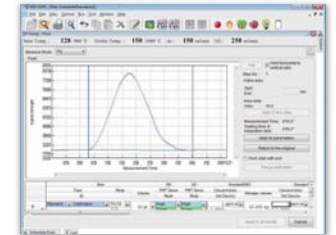

■ STABILITY CHECK

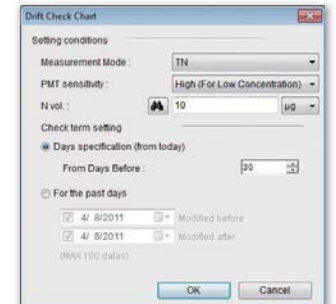

● Methods in Petroleum Products

Element	Sulfur	Nitrogen	Chlorine	Sulfur
Method of detection	Ultraviolet Fluorescence	Chemiluminescence	Coulometric titration	
ASTM	D5453, D6667, D7183, D7551	D4629, D5176, D6069, D7184	D4929, D5808, D7457	D3120, D3246
UOP	987-11, 988-11	981-10	910-07, 779-08	—

MEASUREMENT PRINCIPLE

UVFL Sulfur (SD-210 detector)

Sulfur Measurement

Sample is injected into a high-temperature (800 to 1000°C) pyrolysis tube by argon carrier gas. After sulfur compounds in the sample are pyrolyzed, it is oxidized by O₂ gas.



The produced SO₂ gas is excited (SO₂^{*}) by irradiating the ultraviolet ray $\nu 1$ (190 to 230nm). Then, SO₂^{*} emits the energy (fluorescent ultraviolet ray) and returns to the ground state.



This fluorescent ultraviolet ray $\nu 2$ (300 to 400nm) is received by the photomultiplier tube and AREA value is obtained. The sulfur concentration is obtained by a calibration curve preliminarily drawn with standard solutions.

UVFL Sulfur Diagram

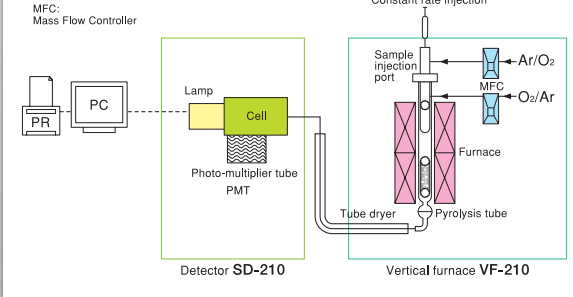

UVFL Sulfur Applications

	Injection (μl)	Analysis (ppm)	RSD (%)
Diesel	40	9.95	0.43
Kerosene	40	1.41	2.95
Gasoline	40	3.79	0.38
BDF	40	1.01	7.07
BTX	40	0.60	0.50
Desulfured light naphtha	40	0.61	6.77
Propane	10ml	2.77	0.76
Butane	25ml	0.18	2.97

Simultaneous Nitrogen and Sulfur

	N (ppm)	RSD (%)	S (ppm)	RSD (%)
Heavy oil	0.32%	0.84	0.48%	1.47
Lub oil	2.11	2.61	7.72	1.42
Diesel	2.91	0.41	9.79	0.27
Gasoline	6.92	0.19	3.79	0.38
Naphtha	4.6	1.78	26.4	0.42

Microcoulometry (MCD-210 detector)

Chlorine Analysis

Samples are combusted in an argon/oxygen atmosphere. The resulting hydrogen chloride is led into a titration cell where it is automatically titrated by silver ions generated coulometrically. The amount of chlorine is calculated from the quantity of electricity required for the titration.

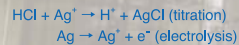

Sulfur Analysis

Samples are combusted in an argon/oxygen atmosphere. The resulting sulfur dioxide is led into a titration cell where it is automatically titrated by triiodide ions generated coulometrically. The amount of sulfur is calculated from the quantity of electricity required for the titration.

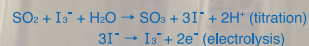

Microcoulometric Titration Diagram

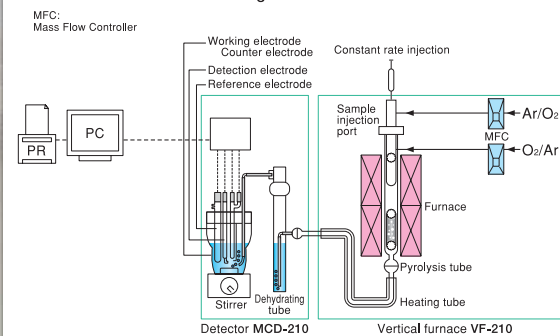

Chemiluminescence Nitrogen (ND-210 detector)

Nitrogen Measurement

Sample is injected into a high-temperature (900 to 1000°C) pyrolysis tube by argon carrier gas. After nitrogen compounds in the sample are pyrolyzed, it is combusted, oxidized, and converted to nitric oxide (NO). After removing moisture from the combustion gas by a dehumidifier (tube dryer), the following oxidation reaction occurs by reaction of NO with ozone.

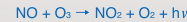

By this reaction, 590 to 2,500nm wavelength light is generated. The optical intensity of this light is proportional to the NO concentration at a wide frequency range. After emitted light is detected by a photomultiplier tube and signal processing is run, an area value is obtained. Using the relation between area and concentration (calibration curve) obtained from standard solutions, the total nitrogen concentration in the sample is calculated. Though some samples generate interfering substances such as SO_x and CO in the process of decomposition to NO, there is little influence on measurement by chemiluminescence method by reduced pressure method.

CLD Nitrogen Diagram

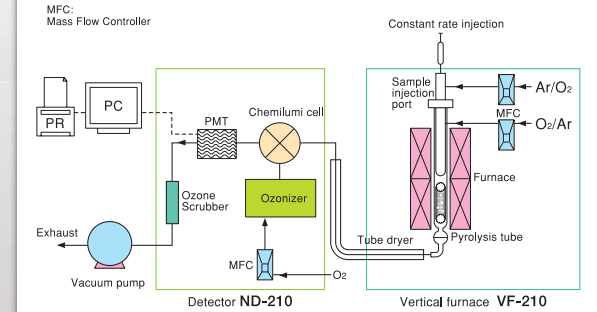

Nitrogen, Standard samples

	Recovery (%)	RSD (%)
10.0 ppm Quinoline	98.5	0.9
0.32% Heavy oil	99.1	0.7
0.11% Heavy oil	104.0	0.1
0.0064% Heavy oil	100.6	0.1

Nitrogen, Application samples

	Analysis (ppm)	RSD (%)
Naphtha	0.8	4.2
Kerosene	3.2	2.2
Diesel	4.1	1.7
Gasoline	2.5	1.7

Nitrogen Aqueous Applications

	Analysis (ppm)	RSD (%)
River Water	3.1	1.70
Factory Disposal	2.6	2.10
Seawater*	0.2	4.80
Sewage Plant (Treated Sewage)	2.2	1.80

* Sea water option

ND-210 Detector with Vacuum Pump



Chlorine Analysis

Samples are combusted in an argon/oxygen atmosphere. The resulting hydrogen chloride is led into a titration cell where it is automatically titrated by silver ions generated coulometrically. The amount of chlorine is calculated from the quantity of electricity required for the titration.

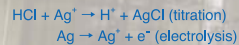

Sulfur Analysis

Samples are combusted in an argon/oxygen atmosphere. The resulting sulfur dioxide is led into a titration cell where it is automatically titrated by triiodide ions generated coulometrically. The amount of sulfur is calculated from the quantity of electricity required for the titration.

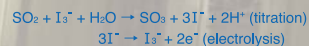

Sample Applications

Chlorine

	Injection (μl)	Analysis (ppm)	RSD (%)
Naphtha	200	0.08	9.8
Gasoline	200	0.53	5.3
Kerosene	200	0.09	5.0
Lub oil	90	1.35	3.2
Diesel 1	200	0.18	7.6
Diesel 2	200	0.05	13.5
Xylene	90	2.47	3.1

Sulfur

	Injection (μl)	Analysis (ppm)	RSD (%)
High Octane	50	7.3	2.3
Gasoline	50	5.5	1.7
Kerosene	50	13.7	1.3
Diesel	50	1.3	3.9
Lub oil 1	50	126	2.1
Lub oil 2	50	37	1.2
Lub oil 3	50	13	2.3

MCD-210 Detector



NSX-2100V

APPLICATION and OPTION

Trap & Release Unit for Sulfur, Model TRU-210 (SD-210)

Enrichment and separation by trap column for sulfur analysis.
Ultra trace analysis down to 5 ppb.

True SO₂ analysis by intrinsic NO_x gas separation.
(UOP 988-11, 987-11)



MODEL	TRU-210 Trap & Release unit
Sample	Liquid, Gaseous
System	SO ₂ gas adsorption and desorption
Measuring Range	5 ppb to 1ppm
Temperature	100-1050°C
Power	100-240VAC, 50/60Hz, 1500VA
Dimension	180(W) x 540(D) x 500(H) mm
Weight	16 kg

*Simultaneous Nitrogen possible via bypass.
*Sample injector, ASC-250L or GI-220 can be used.

Applications TRU-210

Sample	ppb	RSD (%)
Toluene (commercial)	10	4,2
Toluene (Refining)	5,2	5,5
Isopropyl alcohol	10	4,8
Isocotane	14	8,9
n-Decane	27	9,2

● Ultra trace 20ppb

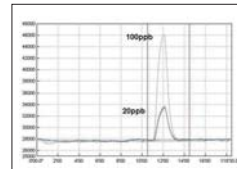

● TRU use this feature as enrichment of SO₂ and separation of NO_x

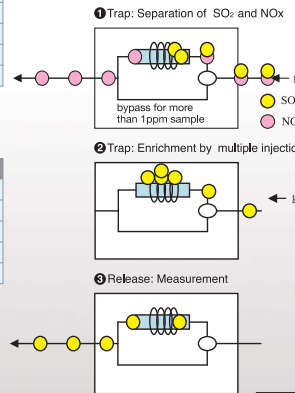

Gas Injector Model GI-260 (SD-210, ND-210, MCD-210)

High level of safety for flammable gases due to automatic injection. (ASTM D6667)



MODEL	GI-260 Liquefied gas (LPG) injector
Sample	(1) Gas (Use the gastight microsyringes), Volatile liquid (2) LPG (Direct connection to the LPG cylinder) * Liquefied natural gas (LNG) is excluded.
Injection	Gas: Syringe port (max. 10 ml/min) Volatile liquid: Syringe port (max. 10 µl) LPG: 30 µl loop
Carrier	Argon
Heat	85°C (max. 105°C)
Max. pressure	6.5 MPa
Power	100-240 VAC, 50/60 Hz, 108VA
Dimension	220(W) x 370(D) x 490(H) mm
Weight	18 kg

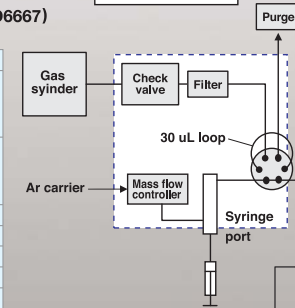

Measurement result

Sample	Volume (µl)	n	ppm	RSD (%)
LPG	30	3	2,88	0,09

Multi-injection

(Sulfur weight (ng)—Peak area; LPG sulfur conc. ca. 20ppm Multi-injection function)

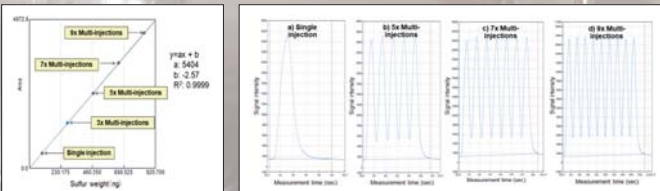

OPTION

ASC-250L



MODEL	ASC-250L Liquid sample changer
Sample	Liquid (non-aqueous, aqueous)
Injection	max 200 µl (depend on sample)
Inj. speed	0.4-50 µl/sec (depend on sample)
Number	50pos in each 2, 4, 6 ml vial tray. (105pos, 2 ml)
Power	100-240VAC, 50/60Hz, 180VA
Dimension	460(W) x 320(D) x 470(H) mm
Weight	16 kg

CRI-210V



MODEL	CRI-210V Constant rate injector for vertical furnace
Sample	Liquid (non-aqueous)
Injection	max 200 µl (depend on sample)
Inj. speed	0.4-1.6 µl/sec (depend on sample)
Syringe	Gastight, 25, 50, 100, 250 µl
Power	100-240VAC, 50/60Hz, 30VA
Dimension	150(W) x 250(D) x 240(H) mm
Weight	5,6 kg

GI-210



MODEL	GI-210 Gas injector
Sample	Non-pressurized gas, Volatile liquid
Injection	10 µl for liquid, 10 ml for gas
Carrier	Argon
Heat	80°C for liquid
Power	100-240VAC, 50/60Hz, 20VA
Dimension	220(W) x 200(D) x 110(H) mm
Weight	4 kg

GI-220



MODEL	GI-220 Gas injector
Sample	Non-pressurized gas, Volatile liquid
Injection	1-10 µl liquid 2-25 ml gas (max. 999 ml)
Carrier	Argon
Heat	80°C for liquid
Power	1000-240VAC, 50/60Hz, 70VA
Dimension	180(W) x 360(D) x 500(H) mm
Weight	13 kg

GI-250



MODEL	GI-250 Gas/LPG injector (Sulfur, Nitrogen)
Measurement Sample	(1) Gastight syringe port: Gaseous or volatile liquid (2) LPG port: Liquefied Petroleum Gas
Injection Volume	(1) Gastight syringe port: 10 ml (gas), 10 µl (volatile liquid), (2) LPG port: 30 µl fixed.
Operation	(1) By manual operation (2) Sampling injection by 6 way manual valve.
Heater	max. 105°C: ASTM D6667
Max. pressure of LPG port	6.5MPa.
Power	AC100V/115V/230V/240V, 50/60Hz, 80VA
Dimension	280(W) x 300(D) x 410(H) mm
Weight	13kg

OTHER OPTION

STC-210L

(UOP 987-11, 981-10)

MODEL	STC-210L Sample temperature controller
Sample	liquid
Number of sample	24 positions
Control	Peltier temperature control for tray and syringe
Cooling	15°C below room temperature
Power	100-240VAC, 50/60Hz, 200VA
Dimension	280(W) x 260(D) x 100(H) mm
Weight	4 kg



WolfLabs

Pricing on any accessories shown can be found by keying the part number into the search box on our website.

The specifications listed in this brochure are subject to change by the manufacturer and therefore cannot be guaranteed to be correct. If there are aspects of the specification that must be guaranteed, please provide these to our sales team so that details can be confirmed.

www.wolflabs.co.uk

Tel : 01759 301142

Fax : 01759 301143

sales@wolflabs.co.uk

Please contact us if this literature doesn't answer all your questions.